



ÜBERSICHT:

Geordnet nach Hersteller, Modell, Baujahr, Lagerort, Ø des Lagerauges finden Sie den passigen Satz für das betreffende Lager.

z.B.:

Fabrikat-Typ	Baujahr	Achse		Ø mm	Artikel-Nr.	i.V.m.
Golf IV	97-03	HA	Hydro/Kunststofflager	69	33224201	S hydr.

Wichtig -

- Drucksatz für den Standard - **S**
- Komplettwerkzeugsatz - **K**
- Satz zum Drücken - **D**
- Satz zum Ziehen - **Z**

ALFA ROMEO

Fabrikat-Typ	Baujahr	Achse		Ø mm	Artikel-Nr.	i.V.m.
Mito	ab`08	VA	Querlenker	39	33313300	S
	ab`08	VA	Querlenker	71	33521300	S

AUDI

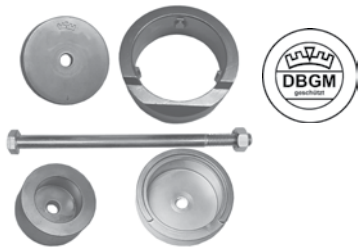

DRUCKSTÜCKSATZ Audi A1, HA



Arbeitsbereich:
HA Ø 69 i.V.m. Standard

Passend für:
Audi A1 ab`10, Seat Ibiza ab`08.

Zeitersparnis:
ca. 0,5 Std.

Artikel-Nr.:
33251300

Fabrikat-Typ	Baujahr	Achse		Ø mm	Artikel-Nr.	i.V.m.
Audi 80/90	72-94	VA	Aggregateträger (alle 4 Lager)	37	33213300	K
		VA,HA	Querlenker (Metallhülse)	37,5	33209300	S + 33206300
Audi 80/90 (B4)		VA,HA	Metallhülse m. Kragen Ø 55	37,5	33209401	S 33206300 + 33209300
Audi 80/90	78-91	HA	Querlenker	41/42	33205301	S
		VA,HA	Querlenker (Gummikragen)	37,5	33210300	S
Audi 80	91-94	HA		56	33216301	K
Audi 100/200	76-91	HA		56	33207300	S
		VA		46	33217300	S
Audi 100	91-94	HA		62	33218300	S
Audi Coupe	88-96	HA	Querlenker	41/42	33205301	S
Audi A1	ab`10	HA	Querlenker	41/42	33205301	S
		HA Bora	Querlenker oben	38/40	33236300	S
		HA	Längslenker	60	33235300	S
		HA		69	33251300	S
		VA	Querlenker	60/31	33211300	S
Audi A2	99-05	HA	Hydro-, Kunststofflager	69	33224201	S hydr.
		HA	Nur Kunststofflager	69	33223300	S
		VA	Konsole Aggregateträger	62	33232302	K
Audi A3	96-03	HA	Hydro-, Kunststofflager	69	33224201	S hydr.
		HA	Nur Kunststofflager	69	33223300	S
		VA	Querlenker	60/31	33211300	S
Audi A3	ab`03	HA	Längslenker	60	33235300	S
		HA	Querlenker oben	38/40	33236300	S
		HA	Kunststofflager	69	33237300	S
		HA	Achsschenkel hinten	36/38	33234300	K
		VA	Querlenker	41/42	33205301	S
		VA	Querlenker vorne	36,5	33532300	S
		VA	Motorträger (Doppellager)	90	33239300/200	Z hydr.
Audi A3 Q.		HA	Achsschenkel oben	43,5	33902300	K
Audi Q3	ab`11	HA	Querlenker	41/42	33205301	S
		HA	Querlenker oben	38/40	33236300	S
		HA	Längslenker	60	33235300	S
Audi A4	94-00	HA	Achskörper	56	33216301	K
		VA	Aggregateträger	71	33250300	K
Audi A4, A6, A8	94-05	VA	Querlenker oben	46	33227300	S
		VA	Querlenker unten	65	33228300	S
		VA	Querlenker unten	40/50	33229300	S

Fabrikat-Typ	Baujahr	Achse		Ø mm	Artikel-Nr.	i.V.m.	
Audi A4	94-08	VA	Aggregateträger	71	33250300	K	
Audi A4	00-08	HA	Achskörper	79	33230300	Z hydr.	
Audi A4 Q.	00-04	HA	Achskörper	56	33243300	Z hydr.	
Audi A6	94-97	HA		62	33218300	S	
Audi A6	97-04	VA	Aggregateträger	71	33250300	K	
Audi A6 Q.	ab`04	HA	Achskörper	56	33243300	Z hydr.	
Audi TT, Roadster	98-07	HA	Achsschenkel oben	43,5/45	33902300	K	
		VA	Querlenker	60/31	33211300	S 	
		HA	Kunststofflager	69	33224201	S hydr.	
		ab`06	VA	Querlenker vorne	36,5	33532300	S 
		HA	Achsschenkel hinten	36/38	33234300	K	
		HA	Querlenker	41/42	33205301	S 	
		HA	Querlenker oben	38/40	33236300	S	
		HA	Längslenker	60	33235300	S	
Audi Q7	ab`03	VA	Querlenker alle 3 Lager	40/46/60	33249300/401	S 	

BMW

DRUCKSTÜCKSATZ E-39, HA Hydrolager

Arbeitsbereich:

HA Achsschenkel Hydrolager Ø 52 i.V.m. Standard







Passend für:



























BMW E-39 95-03, E-39 Touring 97-04, E-38 94-01,
E-53 ab`00, E-63,64 ab`04, E-61 ab`04, E-60 ab`03, Z8 00-03

Artikel-Nr.:

33903300



Fabrikat-Typ	Baujahr	Achse		Ø mm	Artikel-Nr.	i.V.m.
E-24	76-90	HA		68	33901401	Z hydr.
E-28	80-90	HA		68	33901401	Z hydr.
E-30	82-94	HA	Längslenker	27	33922300	S
		VA	Traggelenk außen	41	33911300	S
		VA	Traggelenk Mitte	40	33917301	S
E-31	90-99	VA		58	33915300	S
E-32	86-94	HA		79	33901401	Z hydr.
		VA		58	33915300	S
E-34	88-97	HA		79	33901401	Z hydr.
		VA		58	33915300	S
E-36	90-00	HA	Achsschenkel oben	45	33902300	K 
		HA	Querlenker oben	35	33912300	S
		HA	Längslenker	60	33913300	S
		HA	Achskörper (senkrechte Lager)	60/62	33914300	Z hydr.
E-36	90-98	HA	Achskörper (waagerechte Lager)	45	33902300	K 
		VA	Traggelenk außen	49	33910301	S
		VA	Querlenker außen	60	33916300	S
		VA	Traggelenk Mitte	40	33917301	S
		HA		57	33901401	Z hydr.
E-36 Compact	94-00	HA	Querlenker oben	35	33912300	S
		HA	Längslenker	60	33913300	S
		82-94	HA	Längslenker	27	33922300
E-36 Compact	94-00	VA	Traggelenk außen	49	33910301	S
		VA	Querlenker außen	60	33916300	S
		VA	Traggelenk Mitte	40	33917301	S
E-38	94-01	HA	Achsschenkel (Hydrolager)	52	33903300	Z hydr. 
		HA	Achskörper	80/81	33904300	Z hydr.
E-39	95-03	HA	Achsschenkel (Hydrolager)	52	33903300	Z hydr.
		HA	Achskörper	80/81	33904300	Z hydr. 
E-39 Touring	95-03	HA	Achsschenkel (Hydrolager)	52	33903300	Z hydr.
E-39	97-04	HA	Achskörper	80/81	33904300	Z hydr. 
E-46	ab`98	HA	Achsschenkel oben	45	33902300	K 
		HA	Querlenker oben	35	33912300	S

Fabrikat-Typ	Baujahr	Achse		Ø mm	Artikel-Nr.	i.V.m.
E-46		HA	Längslenker	60	33913300	S
		VA	Traggelenk außen	49	33910301	S
E-53	00-07	HA	Achskörper	95	33919300	Z hydr.
		HA	Achskörper	49	33920300	K 
		HA	Achsschenkel (Hydrolager)	52	33903300	Z hydr.
		HA	Querlenker (Schwinge, 2 Lager)	51	33927300	S
E-60	03-10	HA	Achsschenkel (Hydrolager)	52	33903300	Z hydr. 
		HA	Querlenker (Schwinge, 2 Lager)	51	33927300	S
E-61	ab`04	HA	Achsschenkel (Hydrolager)	52	33903300	Z hydr.
		HA	Querlenker (Schwinge, 2 Lager)	51	33927300	S
E-63	ab`04	HA	Achsschenkel (Hydrolager)	52	33903300	Z hydr.
		HA	Querlenker (Schwinge, 2 Lager)	51	33927300	S
E-64	ab`04	HA	Achsschenkel (Hydrolager)	52	33903300	Z hydr. 
		HA	Querlenker (Schwinge, 2 Lager)	51	33927300	S
E-65	ab`01	HA	Achsschenkel (Hydrolager)	52	33903300	Z hydr.
		HA	Querlenker (Schwinge, 2 Lager)	51	33927300	S
E-66	ab`01	HA	Achsschenkel (Hydrolager)	52	33903300	Z hydr. 
		HA	Querlenker (Schwinge, 2 Lager)	51	33927300	S
E-81	ab`04	HA	Hydrolager	47	33920300	K 
E-82	ab`07	HA	Hydrolager	47	33920300	K 
E-83	ab`04	HA	Querlenker oben	35	33912300	S
		HA	Längslenker	60	33913300	S
E-84	ab`09	HA	Hydrolager	47	33920300	K 
E-85	ab`03	VA	Traggelenk außen	49	33910301	S
		HA	Achsschenkel oben	45	33902300	K 
		HA	Querlenker oben	35	33912300	S
E-87	ab`04	HA	Hydrolager	47	33920300	K 
E-88	ab`08	HA	Hydrolager	47	33920300	K 
E-90	ab`05	HA	Hydrolager	47	33920300	K 
E-91	ab`05	HA	Hydrolager	47	33920300	K 
E-92	ab`00	HA	Hydrolager	47	33920300	K 
E-93	ab`07	HA	Hydrolager	47	33920300	K 
E-88	ab`08	HA	Hydrolager	47	33920300	K 
F-20	ab`10	HA	Hydrolager	47	33920300	K 
F-21	ab`11	HA	Hydrolager	47	33920300	K 
F-25	ab`10	HA	Hydrolager	47	33920300	K 
F-26	ab`14	HA	Hydrolager	47	33920300	K 
F-30	ab`11	HA	Hydrolager	47	33920300	K 
F-31	ab`12	HA	Hydrolager	47	33920300	K 
F-34	ab`13	HA	Hydrolager	47	33920300	K 
F-35	ab`11	HA	Hydrolager	47	33920300	K 
F-80	ab`11	HA	Hydrolager	47	33920300	K 
Z1	88-91	VA	Traggelenk außen	41	33911300	S
		VA	Traggelenk Mitte	40	33917301	S
Z3	95-05	HA		57	33901401	Z hydr.
	82-94	HA	Längslenker	27	33922300	S
		VA	Querlenker außen	60	33916300	S
		VA	Traggelenk außen	49	33910301	S
		VA	Traggelenk mitte	40	33917301	S
Z8	00-03	HA	Achsschenkel (Hydrolager)	52	33903300	Z hydr. 
MINI	ab`01	VA	Silentlager im Lagerbock	66	33925300	K 

CHEVROLET

Fabrikat-Typ	Baujahr	Achse		Ø mm	Artikel-Nr.	i.V.m.
Aveo	ab`06	HA	Achsträger	68	33314300	S
Kalos	ab`05	HA	Achsträger	68	33314300	S
Matiz	ab`05	HA	Achsträger	68	33314300	S
Spark	ab`05	HA	Achsträger	68	33314300	S

DRUCKSTÜCKSATZ Citroen C1, HA

Arbeitsbereich:

HA Ø 60 i.V.m. Standard

Passend für:

Citroen C1 ab`05, Peugeot 107 ab`05, Toyota Aygo ab`05

Artikel-Nr.:

33757300

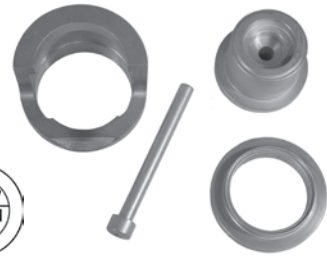

Citroën

Fabrikat-Typ	Baujahr	Achse		Ø mm	Artikel-Nr.	i.V.m.
C1	ab`05	HA		60	33757300	S
C4	ab`04	HA		69	33810300	S
Jumper	ab`94	VA	Traggelenk unten aus QL		33517301	D
Nemo	ab`08	VA	Querlenker	39	33313300	S
		VA	Querlenker	71	33521300	S
Xsara, Xsara Break, Xsara Picasso						
ZX			Achszapfenreparatur HA		33819300	K
Saxo			38			
AX						
Berlingo						



Silentlager

DACIA

Fabrikat-Typ	Baujahr	Achse		Ø mm	Artikel-Nr.	i.V.m.
Logan	ab`04	VA	Traggelenk	37	33812300	S

DAIHATSU

Fabrikat-Typ	Baujahr	Achse		Ø mm	Artikel-Nr.	i.V.m.
Cuore VI	03-07	HA	Achsschenkel	55	33751301	S
Cuore VII	ab`07	HA	Achsschenkel	55	33751301	S

FIAT

DRUCKSTÜCKSATZ FIAT Stilo, HA

Arbeitsbereich:

HA Ø 67 i.V.m. Standard

Passend für:

Fiat Stilo 01-07, Fiat Bravo ab`07, Lancia Delta ab`08

Artikel-Nr.:

33807300

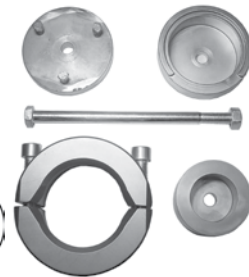

Fabrikat-Typ	Baujahr	Achse		Ø mm	Artikel-Nr.	i.V.m.
Bravo	ab`07	HA	Hydrolager	67	33807300	S hydr.
Croma	ab`05	VA		35	33306300	S
Ducato	ab`94	VA	Traggelenk unten aus QL		33517301	D
Fiorino	ab`08	VA	Querlenker	39	33313300	S
		VA	Querlenker	71	33521300	S
Grande Punto	ab`05	VA	Querlenker	39	33313300	S
		VA	Querlenker	71	33521300	S
Linea	ab`07	VA	Querlenker	39	33313300	S
		VA	Querlenker	71	33521300	S
Punto	94-00	HA	Achsschenkel	40	33516300	K
		VA	Querlenker	39	33313300	S
		VA	Querlenker	71	33521300	S
Punto Evo	09-12	VA	Querlenker	39	33313300	S
		VA	Querlenker	71	33521300	S
Stilo	01-07	HA	Hydrolager	67	33807300	S hydr.

Wussten Sie ...

dass jedes Jahr ca. 750 000 Fahrzeuge in Deutschland angemeldet werden, die alle das gleiche **Motordoppellager** haben? Das Werkzeug, um dieses Lager zu wechseln, ist auf 36 beschrieben.



FORD

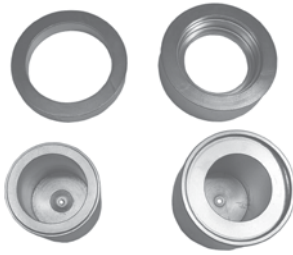

DRUCKSTÜCKSATZ FORD Focus, Längslenker

Arbeitsbereich:

HA Längslenker Ø 60 i.V.m. Standard

Passend für:

Ford Focus I, II, III ab`98, Ford Focus C-Max I, II ab`03,
Ford Kuga I, II ab`08, Mazda 3 BK, BL ab`03, Mazda 5 ab`05, Mazda 6 02-05,
Volvo C30 06-12, Volvo S40 II 04-12, Volvo V40 ab`12, Volvo V50 04-12

Artikel-Nr.:

33408300

Fabrikat-Typ	Baujahr	Achse		Ø mm	Artikel-Nr.	i.V.m.		
B-MAX	ab`12	HA	Achsträger	68	33421300	S		
C-Max I, II	ab`03	HA	Längslenker	60	33408300	S		
		VA	Querlenker Lagerbock	74	33418303	S		
Fiesta Kasten, Ka,	ab`95	VA		37	33404300	S		
Fiesta	ab`95	HA	Längslenker	63	33410300	S		
Fiesta IV	95-02	VA	Querlenker	66	33403301	S		
Fiesta V	02-08	HA	Achsträger	60	33420300	S		
		VA	Querlenker Lagerbock	74	33418303	S		
Fiesta VI	ab`08	HA	Achsträger	68	33421300	S		
Focus I, II, III	ab`98	HA	Längslenker	60	33408300	S		
		VA	Querlenker Lagerbock	74	33418303	S		
Fusion	02-12	HA	Achsträger	60	33420300	S		
		VA	Querlenker Lagerbock	73	33418303	S		
Galaxy	95-06	VA/HA	Querlenker	35/45	33220301	S		
	95-06	HA		95	33246300	Z hydr.		
	ab`06	HA	Längslenker	90	33416200/300	K		
		VA	Querlenker	60	33417300	S		
Kuga I, II	ab`08	HA	Längslenker	60	33408300	S		
Mondeo I, II	93-00	VA		46/47	33401300	S		
		VA	Querlenker	60	33402300	S		
Mondeo II	96-00	VA		54	33409300	S		
Mondeo III	00-07	VA		35	33414300	Z hydr.		
		HA		46/52	33411300	Z hydr.		
		HA	Längslenker	60	33402300	S		
Mondeo Tounier	00-07	HA		90	33416200	K		
Mondeo IV	ab`07	HA	Achsschenkel	36/38	33234300	K		
		HA	Längslenker	90	33416200/300	K		
		VA	Querlenker	60	33417300	S		
		VA	Querlenker Lagerbock	90	33418303	S		
Puma,Courier		VA	Querlenker	66	33403301	S		
		HA	Längslenker	63	33410300	S		
S-Max	ab`06	HA	Längslenker	90	33416200/300	K		
		VA	Querlenker	60	33417300	S		
		VA	Querlenker Lagerbock	90	33418303	S		
Tourneo Connect	02-13	VA	Achsschenkel, Traggelenk	43/45	33407300	K + 2-Arm-Abzieher		
Transit	00-06	VA	Querlenker	66	33403301	S		
		VA	Traggelenkkonus aus Querlenker drücken		33517301	D hydr.		
		00-13	VA	Traggelenk Achsschenkel	43/45	33407300	K + 2-Arm-Abzieher	
		00-13	VA	Traggelenkkonus aus Querlenker drücken		33419301	D hydr.	

HONDA



DRUCKSTÜCKSATZ Honda Civic, Längslenker

Arbeitsbereich:

HA Längslenker Ø 80 hydraulisch ziehen

Passend für:



Honda Civic 87-01, Honda CRX 87-91, Rover 200 85-99, Rover 25 ab`91,
Rover 400 99-00, Rover 45 ab`00

Artikel-Nr.:

33730300

Fabrikat-Typ	Baujahr	Achse		Ø mm	Artikel-Nr.	i.V.m.	
Accord	03-06	VA	Traggelenk unten	43	33732300	D- Montagebügel	33102300
Civic	87-01	HA	Längslenker	80	33730300	Z hydr.	
CRX	87-91	HA	Längslenker	80	33730300	Z hydr.	

HYUNDAI

Fabrikat-Typ	Baujahr	Achse		Ø mm	Artikel-Nr.	i.V.m.	
Genesis	ab`08	HA	Achsschenkel (Kugelgelenk)	44	33902300	K	
i 30/CW	07-12	HA	Achsschenkel (Kugelgelenk)	44	33902300	K	
		HA	Längslenker	70	33312301	S	
i 30/GD	ab`12	HA	Achsschenkel (Kugelgelenk)	44	33902300	K	
i 40/CW	ab`11	HA	Achsschenkel (Kugelgelenk)	44	33902300	K	
Santa FE	ab`12	HA	Achsschenkel (Kugelgelenk)	44	33902300	K	

IVECO

Fabrikat-Typ	Baujahr	Achse		Ø mm	Artikel-Nr.	i.V.m.	
Daily	99-06	VA	Traggelenk unten aus Achsschenkel drücken		33517301	D	
		VA	Traggelenk aus Querlenker unten + oben	44/45	33781300	S	

KIA

Fabrikat-Typ	Baujahr	Achse		Ø mm	Artikel-Nr.	i.V.m.	
Carens	ab`06	HA	Achsschenkel (Kugelgelenk)	44	33902300	K	
Carnival	ab`06	HA	Achsschenkel (Kugelgelenk)	44	33902300	K	
Cee`d/SW	ab`08	HA	Achsschenkel (Kugelgelenk)	44	33902300	K	
Cee`d	08-12	HA	Längslenker	70	33312301	S	
Pro Cee`d	ab`08	HA	Achsschenkel (Kugelgelenk)	44	33902300	K	
Clarus	ab`96	VA	Traggelenk unten	42,5	33701300	S	
Sportage	ab`10	HA	Achsschenkel (Kugelgelenk)	44	33902300	K	
Sorento II	ab`12	HA	Achsschenkel (Kugelgelenk)	44	33902300	K	

LANCIA

Fabrikat-Typ	Baujahr	Achse		Ø mm	Artikel-Nr.	i.V.m.	
Delta	ab`08	HA	Hydrolager	67	33807300	S hydr.	
Lancia 840	95-03	HA	Achsschenkel	40	33516300	K	

DRUCKSTÜCKSATZ Mazda, VA Traggelenk

Arbeitsbereich:

VA Traggelenk unten Ø 42,5 i.V.m. Standard

Passend für:







Mazda 323 VI, 626, 929, MP VII, MX-6, Premacy, Tribute, Xedos, Kia Clarus ab`96

Artikel-Nr.:

33701300



MAZDA

Fabrikat-Typ	Baujahr	Achse		Ø mm	Artikel-Nr.	i.V.m.	
323VI, 626, 929, MPVII ab`82		VA	Traggelenk unten	42,5	33701300	S	
MX 6, Premacy, Tribute, Xedos6							
121-III	ab`96	VA		66	33403301	S	
121-III		VA		37	33404300	S	
2	ab`03	HA	Achsträger	60	33420300	S	
		VA	Querlenker Lagerbock	73	33418303	S	
3 BK, BL	ab`03	HA		60	33408300	S	
		VA	Querlenker Lagerbock	74	33418303	S	
5	ab`05	HA		60	33408300	S	
		VA	Querlenker Lagerbock	74	33418303	S	
6	02-07	HA		60	33408300	S	

Wussten Sie ...

dass seit Paschke Profitec 1988 den Standard herausgebracht hat, dieser unzählige Male kopiert wurde?







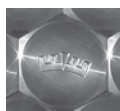

















Einschließlich der Abmessung der Aufnahme.















Ein echter Standard!

Nur echt mit der Krone!



MB



Fabrikat-Typ	Baujahr	Achse		Ø mm	Artikel-Nr.	i.V.m.
116 (S-Klasse)	72-80	VA	Traggelenk	45	33524300	D hydr.
123	76-85	VA	Traggelenk	45	33524300	D hydr.
124 (E-Klasse)	84-98	HA	Achsschenkel (Hydrolager)	40	33501300	K 
		HA	Differentialaufhängung	47	33502300	K
		VA	Traggelenk	46	33503301	S
		VA		48	33510300	S
126 (S-Klasse)	79-91	VA	Traggelenk	45	33524300	D hydr.
129 (SL-Klasse)	89-01	HA	Achsschenkel (Hydrolager)	40	33501300	K 
		VA	Traggelenk	46	33503301	S
		VA		48	33510300	S
140 (S-Klasse)	91-99	HA	Achsschenkel (Hydrolager)	40	33501300	K 
		VA		48	33510300	S
163 (M-Klasse)	98-05	VA/HA	Traggelenk	45	33520300	D hydr.
164 (M-Klasse)	05-11	VA/HA	Traggelenk	45	33520300	D hydr.
168 (A-Klasse)	97-04	HA	Achsschenkel	40	33516300	K
168 (A-Klasse)	97-04	VA	Querlenker	60	33533300	S
168 (A-Klasse)	97-04	VA	Querlenker	40	33534300	S
169 (A-Klasse)	04-12	VA	Querlenker	60	33533300	S
169 (A-Klasse)	04-12	VA	Querlenker	40	33534300	S
170 (SLK-Klasse)	96-04	HA	Achsschenkel (Hydrolager)	40	33501300	K 
		VA	Querlenker unten	50/60	33511302	S
171 (SLK-Klasse)	04-11	HA	Achsschenkel (Hydrolager)	40	33501300	K 
		HA	Achskörper Lager vorn	76	33537401	K 33537300
		HA	Achskörper Lager hinten	89	33538401	K 33538300
172 (SLK-Klasse)	ab`11	HA	Achsschenkel (Hydrolager)	40	33501300	K 
		HA	Achskörper Lager vorn	76	33537401	K 33537300
		HA	Achskörper Lager hinten	89	33538401	K 33538300
		VA	Querlenker unten	70	33521300	S
		HA	Achsschenkel (Hydrolager)	40	33501300	K 
201 (190 er)	82-93	VA	Traggelenk	46	33503301	S
		VA		48	33510300	S
		HA	Achsschenkel (Hydrolager)	40	33501300	K 
202 (C-Klasse)	93-01	VA	Querlenker unten	50/60	33511302	S
		HA	Achsschenkel (Hydrolager)	40	33501300	K 
203 (C-Klasse)	00-07	HA	Achsschenkel (Hydrolager)	40	33501300	K 
		HA	Achskörper Lager vorn	76	33537401	K 33537300
		HA	Achskörper Lager hinten	89	33538401	K 33538300
		VA	Querlenker unten	70	33521300	S
203 (CLC-Klasse)	08-11	HA	Achskörper Lager vorn	76	33537401	K 33537300
		HA	Achskörper Lager hinten	89	33538401	K 33538300
204 (C-Klasse)	ab`07	HA	Achsschenkel (Hydrolager)	40	33501300	K 
204 (C-Klasse)	ab`07	HA	Hinterachse vorn	76	33537300	K 
204 (C-Klasse)	ab`07	HA	Hinterachse hinten	89	33538300	K 
204 (GLK-Klasse)	ab`08	HA	Achsschenkel (Hydrolager)	40	33501300	K 
204 (GLK-Klasse)	ab`08	HA	Hinterachse vorn	76	33537300	K 
204 (GLK-Klasse)	ab`08	HA	Hinterachse hinten	89	33538300	K 
207 (E-Klasse)	ab`09	HA	Achsschenkel (Hydrolager)	40	33501300	K 
207 (E-Klasse)	ab`09	HA	Hinterachse vorn	76	33537300	K 
207 (E-Klasse)	ab`07	HA	Hinterachse hinten	89	33538300	K 
208 (CLK-Klasse)	97-02	HA	Achsschenkel (Hydrolager)	40	33501300	K 
		VA	Querlenker unten	50/60	33511302	S
209 (CLK-Klasse)	ab`02	HA	Achsschenkel (Hydrolager)	40	33501300	K 
		HA	Achskörper Lager vorn	76	33537401	K 33537300
		HA	Achskörper Lager hinten	89	33538401	K 33538300
		VA	Querlenker unten	70	33521300	S
210 (E-Klasse)	95-03	HA	Achsschenkel (Hydrolager)	40	33501300	K 
		VA	Querlenker unten	50/60	33512302	S
211 (E-Klasse)	89-01 02-09	HA	Achsschenkel (Hydrolager)	40	33501300	K 
		VA	Querlenker unten	50/60	33512302	S
		VA	Traggelenk außen	41	33519302	D hydr. 
		VA	Traggelenk unten Mitte	34	33522300	S
		VA	Querlenker unten	70	33521300	S
		VA	Querlenker unten (geschlitztes Lager)	50	33527300	S

Fabrikat-Typ	Baujahr	Achse		Ø mm	Artikel-Nr.	i.V.m.
211 (E-Klasse)	02-09	HA	Achskörper Lager vorn	76	33537401	K 33537300
		HA	Achskörper Lager hinten	89	33538401	K 33538300
212 (E-Klasse)	ab`09	HA	Achsschenkel (Hydrolager)	40	33501300	K 
212 (E-Klasse)	ab`09	HA	Hinterachse vorn	76	33537300	K 
212 (E-Klasse)	ab`09	HA	Hinterachse hinten	89	33538300	K 
215 (S-Klasse)	99-06	HA	Achsschenkel (Hydrolager)	40	33501300	K 
		VA	Traggelenk außen	41	33519302	D hydr. 
216 (S-Klasse)	ab`06	HA	Achsschenkel (Hydrolager)	40	33501300	K 
218 (CLS-Klasse)	ab`11	HA	Hinterachse vorn	76	33537300	K 
218 (CLS-Klasse)	ab`11	HA	Hinterachse hinten	89	33538300	K 
219 (CLS-Klasse)	ab`04	VA	Traggelenk außen	41	33519302	D hydr. 
		HA	Achsschenkel (Hydrolager)	40	33501300	K 
		HA	Achskörper Lager vorn	76	33537401	K 33537300
		HA	Achskörper Lager hinten	89	33538401	K 33538300
		VA	Querlenker unten	70	33521300	S
		VA	Traggelenk unten Mitte	34	33522300	S
		VA	Querlenker unten (geschlitztes Lager)	50	33527300	S
220 (S-Klasse)	98-05	HA	Achsschenkel (Hydrolager)	40	33501300	K 
		VA	Querlenker unten	50/60	33512302	S
		VA	Traggelenk unten Mitte	34	33522300	S
		VA	Querlenker unten (geschlitztes Lager)	50	33527300	S
		VA	Traggelenk außen	41	33519302	D hydr. 
221 (S-Klasse)	ab`05	HA	Achsschenkel (Hydrolager)	40	33501300	K 
230 (SL-Klasse)	01-12	VA	Traggelenk außen	41	33519302	D hydr. 
		VA	Traggelenk unten Mitte	34	33522300	S
Sprinter	95-06	VA/HA	Stabi	26	33504301	K 33537300
		VA/HA	Stoßdämpfergummi	30/40	33507300	S
		VA	Traggelenk (Kragen Ø 60/62)	45	33513303	S hydr.
		VA	Traggelenkkonus aus Achsschenkel drücken		33517301	D hydr.
		VA	Querlenker 2 Lager	38	33523300	S
Sprinter	ab`06	VA	Traggelenk (Kragen Ø 60)	45	33513303	S hydr.
	ab`06	VA	Traggelenkkonus aus Achsschenkel drücken		33517301	D hydr.
Transporter 207-814 D 77-96		VA	Querlenker 2 Lager	47	33526300	S
		VA/HA	Stabi	26/28	33504301	K
Vito/V-Kl. (W638)	96-03	VA	Querlenker	37	33532300	S
Vito/Viano (W639)	ab`03	VA	Querlenker	37	33532300	S

MITSUBISHI

Fabrikat-Typ	Baujahr	Achse		Ø mm	Artikel-Nr.	i.V.m.
Colt IV+V	92-05	HA	Längslenker hinten (Schlitz +Stahlbuchse)	70	33710300	S
Colt IV+V	92-05	HA	Längslenker hinten (nur Stahlbuchse)	70	33710401	S
Lancer V+VI	92-03	HA	Längslenker hinten (Schlitz +Stahlbuchse)	70	33710300	S
Lancer V+VI	92-03	HA	Längslenker hinten (nur Stahlbuchse)	70	33710401	S
Carisma	95-06	HA	Längslenker hinten (Schlitz +Stahlbuchse)	70	33710300	S
Carisma	95-06	HA	Längslenker hinten (nur Stahlbuchse)	70	33710401	S
Space Star	95-04	HA	Längslenker hinten (Schlitz +Stahlbuchse)	70	33710300	S
Space Star	95-04	HA	Längslenker hinten (nur Stahlbuchse)	70	33710401	S

NISSAN

Fabrikat-Typ	Baujahr	Achse		Ø mm	Artikel-Nr.	i.V.m.
Almera Tino	ab`00	VA	Traggelenk	40	33917301	S
Interstar	ab`02	VA	Traggelenk oben	46/45	33519302	D hydr. 
Interstar	ab`02	VA	Traggelenk unten	43	33309401	D hydr. + 33231300 oder 33519302
Interstar	ab`02	VA	Traggelenk unten	43	33309402	S
Maxima QX	00-03	VA	Traggelenk	40	33917301	S
Micra	ab`03	VA	Querlenker außen	58	33814300	S
Navarra	ab`05	VA	Traggelenk (Kragen Ø 60/62)	45	33513303	S hydr. 
Note	ab`06	VA	Querlenker außen	58	33814300	S
Pathfinder	ab`05	VA	Traggelenk (Kragen Ø 60/62)	45	33513303	S hydr. 
Primastar	ab`01	VA	Querlenker Mitte + außen	55/58	33809300	S
Primera	ab`02	VA	Traggelenk	40	33917301	S
Tiida	ab`07	VA	Querlenker außen	58	33814300	S

OPEL

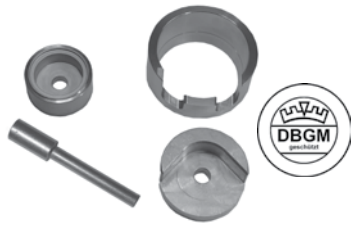

DRUCKSTÜCKSATZ Opel Astra H, Zafira B, HA

Arbeitsbereich:
HA Ø 70/67 i.V.m. Standard

Passend für:
Opel Astra H 04-09, Zafira 05-11, Meriva ab`10

Artikel-Nr.:
33311300

Fabrikat-Typ	Baujahr	Achse		Ø mm	Artikel-Nr.	i.V.m.
Adam	ab`12	VA	Querlenker	39	33313300	S
	ab`12	VA	Querlenker	71	33521300	S
Astra G	98-05	HA		59	33310300	S
Astra G,H	ab`98	VA		35/47	33306300	S
Astra F	91-99	VA		59/37	33307300	S
Astra H	04-09	HA		70/67	33311300	S
Calibra	90-97	VA		59/37	33307300	S
Combo	ab`01	HA		59	33310300	S
	ab`00	HA		59	33310300	S
Corsa	ab`06	VA	Querlenker	39	33313300	S
	ab`06	VA	Querlenker	71	33521300	S
Insignia	ab`08	HA	Längslenker	70	33312301	S
Meriva	ab`03	HA		59	33310300	S
	ab`10	HA		70/67	33311300	S
Movano	ab`98	VA	Traggelenk oben	45/46	33519302	D hydr.
		VA	Traggelenk unten	43	33309401	D hydr. + 33231300 oder 33519302
		VA	Traggelenk unten	43	33309402	S
Omega	86-03	VA		47,5	33304300	S
		VA		58	33305300	S
	94-03	HA		95	33246300	Z hydr.
Vectra A	88-95	VA		59/37	33307300	S
Vectra B	95-03	HA	Längslenker	60	33301300	S
		HA	Achskörper	63/67	33302300	Z hydr.
		HA	Achsschenkel (Hydrolager)	45	33303300	K
Vectra B,C	ab`95	VA		35/47	33306300	S
Vectra C	ab`02	HA	Hydrolager	47	33920300	K
Zafira	ab`99	VA		35/47	33306300	S
	99-05	HA		59	33310300	S
	ab`05	HA		70/67	33311300	S
Signum	ab`03	VA		35/47	33306300	S
Vivaro	ab`01	VA	Querlenker Mitte + außen	55/58	33809300	S

PEUGEOT

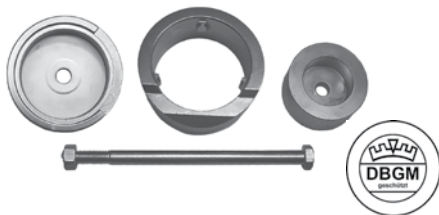

DRUCKSTÜCKSATZ Peugeot 307, HA

Arbeitsbereich:
HA Ø 69 i.V.m. Standard

Passend für:
Peugeot 307 ab`00, Citroen C4 ab`04

Artikel-Nr.:
33810300

Fabrikat-Typ	Baujahr	Achse		Ø mm	Artikel-Nr.	i.V.m.
Bipper	ab`08	VA	Querlenker	39	33313300	S
	ab`08	VA	Querlenker	71	33521300	S
Boxer	ab`94	VA	Traggelenk unten aus QL		33517301	D
307	ab`00	HA		69	33810300	S
107	ab`05	HA		60	33757300	S

106I, 106II, 106 Van						
205I, 205 Cabrio, 205 II, 205 Kasten						
206, 206 CC, 206 S16, 206 SW, 206 Van			Achszapfenreparatur HA		33819300	K
306, 306 Cabrio, 306 Break, 306 Van			38			
309I, 309 II						
405I, 405II, 405II Break						
Partner						

Fabrikat-Typ	Baujahr	Achse	Ø mm	Artikel-Nr.	i.V.m.
Cayenne	ab`03	VA	40/46/60	33249300/401	S 



DRUCKSTÜCKSATZ Renault Laguna II, HA

Arbeitsbereich:
HA Ø 78 i.V.m. Standard

Passend für:
Renault Laguna ab`01

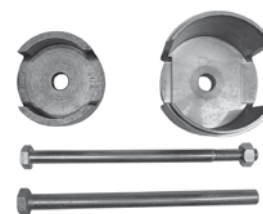
Artikel-Nr.:
33805300



Fabrikat-Typ	Baujahr	Achse		Ø mm	Artikel-Nr.	i.V.m.
Avantime	01-03	VA	Traggelenk	38	33801300	S
		VA	Querlenker außen	57	33802301	S
		VA	Querlenker Mitte	55	33803300	Z hydr.
Clio II	98-05	HA		45	33806300	S
Clio III	ab`05	VA	Traggelenk	37	33812300	S
	ab`03	VA	Querlenker außen	58	33814300	S
Clio Grandtour	ab`03	VA	Querlenker außen	58	33814300	S
Espace III	96-02	VA	Traggelenk	38	33801300	S
Espace III		VA	Querlenker außen	70	33802301	S
Espace IV	ab`02	VA	Querlenker Mitte, außen	55/58	33809300	S
Laguna, Espace	93-02	VA	Traggelenk	38	33801300	S
		VA	Querlenker außen	70	33802301	S
		VA	Querlenker Mitte	55	33803300	Z hydr.
Laguna II	01-07	HA		78	33805300	S 
		VA	Querlenker Mitte, außen	55/58	33809300	S
Laguna III	ab`07	HA		78	33805300	S 
Kangoo 4x4	01-07	HA	Achskörper	70	33815300	Z hydr.
		HA	Achskörper (waagerechte Lager)	80	33816300	Z hydr.
Master	ab`98	VA	Traggelenk oben	45/46	33519302	D hydr. 
		VA	Traggelenk unten	43	33309401	D hydr.+ 33231300 oder 33519302
		VA	Traggelenk unten	43	33309402	S
Megane II	ab`02	VA	Traggelenk	37	33812300	S
		VA	Querlenker Mitte	33	33813300	S
		VA	Querlenker außen	58	33814300	S
Megane II, III		HA	Achsträger	68	33421300	S
Megane III	ab`08	VA	Traggelenk	37	33812300	S
Modus	ab`04	VA	Traggelenk	37	33812300	S
		VA	Querlenker außen	58	33814300	S
Safrane	92-00	VA	Traggelenk	38	33801300	S
		VA	Querlenker Mitte	55	33803300	S
		VA	Querlenker außen	57	33802301	S
Scenic II	ab`03	VA	Traggelenk	37	33812300	S
		VA	Querlenker Mitte	33	33813300	S
		VA	Querlenker außen	58	33814300	S
Scenic II, III	ab`03	HA	Achsträger	68	33421300	S
Traffic II	ab`01	VA	Querlenker Mitte, außen	55/58	33809300	S
Twingo	ab`07	HA		45	33806300	S
VelSatis	ab`02	VA	Querlenker Mitte	55	33803300	Z hydr.

Fabrikat-Typ	Baujahr	Achse		Ø mm	Artikel-Nr.	i.V.m.
Rover 200	85-99	HA	Längslenker	80	33730300	Z hydr.
Rover 25	ab`91	HA	Längslenker	80	33730300	Z hydr.
Rover 400	99-00	HA	Längslenker	80	33730300	Z hydr.
Rover 45	ab`00	HA	Längslenker	80	33730300	Z hydr.

Fabrikat-Typ	Baujahr	Achse		Ø mm	Artikel-Nr.	i.V.m.
Saab 9-5	ab`97	HA	Achsschenkel (Hydrolager)	45	33303300	K
		HA	Längslenker	60	33301300	S
Saab 9-5, 9-3	ab`97	VA	Achsschenkel	35/47	33306300	S
Saab 9-5	ab`10	H	Längslenker	70	33312301	S

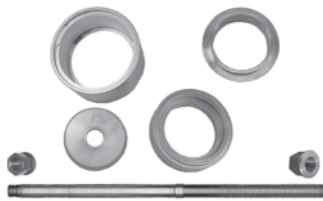
SEAT**DRUCKSTÜCKSATZ Seat Alhambra, HA****Arbeitsbereich:**

HA Ø 95 hydraulisch ziehen

Passend für:Seat Alhambra 96-10, Ford Galaxy 95-06, VW Sharan 95-10,
Opel Omega 94-03**Artikel-Nr.:****33246300**

Silentlager

Fabrikat-Typ	Baujahr	Achse		Ø mm	Artikel-Nr.	i.V.m.	
Alhambra	96-10	VA/HA	Querlenker	35/45	33220301	S	
	96-10	HA		95	33246300	Z hydr.	
	ab`10	VA	Querlenker vorne	36,5	33532300	S	
		HA	Achsschenkel hinten	36/38	33234300	K	
		HA	Querlenker oben	38/40	33236300	S	
		VA	Motorträger (Doppellager)	90	33239300/200	Z hydr.	
Altea	ab`04	HA	Querlenker	41/42	33205301	S	
		HA	Achsschenkel hinten	36/38	33234300	K	
		HA	Längslenker	60	33235300	S	
		HA	Querlenker oben	38/40	33236300	S	
		VA	Konsole klein	62	33232302	K	
		VA	Querlenker	36,5	33532300	S	
		VA	Motorträger (Doppellager)	90	33239300/200	Z hydr.	
Arosa	97-04	HA	Kunststofflager	56	33225300	S	
Cordoba	93-99	VA		60/31	33211300	S	
		HA	Kunststofflager	56	33225300	S	
Cordoba	02-09	VA		30	33233300	S	
		HA	Hydro-, Kunststofflager	69	33224201	S hydr.	
		HA	Nur Kunststofflager	69	33223300	S	
		VA	Konsole Aggregateträger	62	33232302	K	
Exeo	ab`09	VA	Aggregateträger	71	33250300	K	
		HA	Achskörper	79	33230300	Z hydr.	
Ibiza	93-02	VA		60/31	33211300	S	
		HA	Kunststofflager	56	33225300	S	
Ibiza	02-09	VA	Konsole Aggregateträger	62	33232302	K	
		VA	Querlenker	30	33233300	S	
		HA	Hydro-, Kunststofflager	69	33224201	S hydr.	
		HA	Nur Kunststofflager	69	33223300	S	
Ibiza	ab`08	HA		69	33251300	S	
Inca	95-03	VA		60/31	33211300	S	
Leon	99-06	VA		60/31	33211300	S	
		HA	Achsschenkel oben	43,5	33902300	K	
		99-12	HA	Hydro-, Kunststofflager	69	33224201	S hydr.
		99-12	HA	Nur Kunststofflager	69	33223300	S
Leon	ab`05	HA	Querlenker	41/42	33205301	S	
		HA	Achsschenkel hinten	36/38	33234300	K	
		HA	Längslenker	60	33235300	S	
		HA	Querlenker oben	38/40	33236300	S	
		VA	Konsole klein	62	33232302	K	
		VA	Querlenker	36,5	33532300	S	
		VA	Motorträger (Doppellager)	90	33239300/200	Z hydr.	
		VA	Querlenker	60/31	33211300	S	
Toledo I	91-99	HA		44	33208300	S	
		HA		56	33215302	S hydr.	
Toledo I bis IV	ab`91	VA		60/31	33211300	S	
Toledo II / III	99-04	HA	Hydro-, Kunststofflager	69	33224201	S hydr.	
		HA	Nur Kunststofflager	69	33223300	S	
Toledo III	ab`04	VA	Konsole klein	62	33232302	K	
		VA	Querlenker	36,5	33532300	S	
	ab`05	HA	Querlenker	41/42	33205301	S	
		HA	Längslenker	60	33235300	S	
		HA	Querlenker oben	38/40	33236300	S	
		VA	Motorträger (Doppellager)	90	33239300/200	Z hydr.	
		HA	Achsschenkel hinten	36/38	33234300	K	

DRUCKSTÜCKSATZ Skoda Citigo, HA

Arbeitsbereich:

HA Ø 56 i.V.m. Standard









































Passend für:

Skoda Citigo ab`11, VW Up ab`11, Seat Mii ab`11

Artikel-Nr.:

33248300



Fabrikat-Typ	Baujahr	Achse		Ø mm	Artikel-Nr.	i.V.m.			
Citigo	ab`11	VA	Querlenker	60/31	33211300	S			
		HA		56	33248300	S			
Fabia	99-07	HA	Hydro-, Kunststofflager	69	33224201	S hydr.			
		HA	Nur Kunststofflager	69	33223300	S			
Fabia	ab`00	VA	Konsole Aggregateträger	62	33232302	K			
		VA		30	33233300	S			
		VA	Querlenker	60/31	33211300	S			
Octavia	97-13	HA	Hydro-, Kunststofflager	69	33224201	S hydr.			
		HA	Nur Kunststofflager	69	33223300	S			
		VA	Querlenker	60/31	33211300	S			
Octavia 4x4	99-04	HA	Achsschenkel oben	43,5	33902300	K			
Octavia	ab`04	HA	Querlenker	41/42	33205301	S			
		HA	Achsschenkel hinten	36/38	33234300	K			
		HA	Längslenker	60	33235300	S			
		HA	Querlenker oben	38/40	33236300	S			
		HA	Achskörper	69	33237300	S/Z			
		VA	Konsole klein	62	33232302	K			
		VA	Querlenker	36,5	33532300	S			
		VA	Motorträger (Doppellager)	90	33239300/200	Z hydr.			
		Rapid	ab`12	VA	Querlenker	60/31	33211300	S	
		Roomster	06-15	HA	Hydro-, Kunststofflager	69	33224201	S hydr.	
VA	Konsole Aggregateträger			62	33232302	K			
HA	Hydro-, Kunststofflager			69	33224201	S hydr.			
HA	Nur Kunststofflager			69	33223300	S			
VA				30	33233300	S			
Superb	ab`02	VA	Querlenker	60/31	33211300	S			
		VA	Getriebeträger	71	33250300	K			
		VA	Querlenker oben	46	33227300	S			
		VA	Querlenker unten	65	33228300	S			
		VA	Querlenker unten	40/50	33229300	S			
	ab`08	VA	Querlenker	36,5	33532300	S			
		HA	Achsschenkel hinten	36/38	33234300	K			
		HA	Längslenker	60	33235300	S			
		HA	Querlenker oben	38/40	33236300	S			
		HA	Querlenker	41/42	33205301	S			
Yeti	ab`09	VA	Motorträger (Doppellager)	90	33239300/200	Z hydr.			
		VA	Querlenker	36,5	33532300	S			
		HA	Achsschenkel hinten	36/38	33234300	K			
		HA	Längslenker	60	33235300	S			
		HA	Querlenker oben	38/40	33236300	S			
		HA	Querlenker	41/42	33205301	S			



Reifen- und KFZ-Service Kirschbaum, Erfurt, Herr Burkert: „Wir setzen das Paschke Werkzeug gerne ein, da bereits nach kurzer Einarbeitungszeit eine deutliche Zeitersparnis erreicht wird. Die Lieferfähigkeit und Flexibilität ist außergewöhnlich gut. Am meisten schätzen wir die gute und freundliche telefonische Erreichbarkeit und das schnelle und direkte Eingehen auf individuelle Problemstellungen und Wünsche.“

TOYOTA





DRUCKSTÜCKSATZ Toyota Corolla E12, HA

Arbeitsbereich:
HA Ø 65 i.V.m. Standard

Passend für:
Toyota Corolla E12 02-07, Corolla Verso 02-09, Prius II 03-09

Vorteil:
einziges verfügbares Werkzeug

Artikel-Nr.:
33750301

Fabrikat-Typ	Baujahr	Achse		Ø mm	Artikel-Nr.	i.V.m.
Aygo	ab'05	HA		60	33757300	S
Corolla	02-07	HA	Achsschenkel	65	33750301	S 
Prius	03-09	HA	Achsschenkel	65	33750301	S 
Picnic	96-01	HA	Achsschenkel	55	33751301	S
Yaris	99-06	HA	Achsschenkel	55	33751301	S
		VA	Querlenker außen	55	33752300	S
		VA	Querlenker mitte	31	33753300	S
		VA	Traggelenk	37	33754300	S
Yaris	ab'06	HA	Achsschenkel	69	33755300	S
Yaris Verso	ab'99	HA	Achsschenkel	55	33751301	S
		VA	Querlenker außen	55	33752300	S
		VA	Querlenker mitte	31	33753300	S
		VA	Traggelenk	37	33754300	S

VW

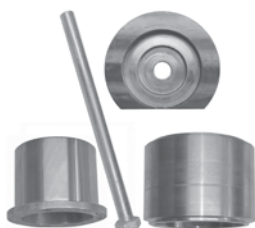

DRUCKSTÜCKSATZ VW Touareg, VA QL

Arbeitsbereich:
VA Querlenker Ø 60 i.V.m. Standard











Passend für:
Touareg ab'02, Porsche Cayenne ab'02, Audi Q7 ab'06

Artikel-Nr.:
33249300

Fabrikat-Typ	Baujahr	Achse		Ø mm	Artikel-Nr.	i.V.m.
Bora	98-05	HA	Hydro-, Kunststofflager	69	33224201	S hydr. 
		HA	Nur Kunststofflager	69	33223300	S
		VA		60/31	33211300	S 
Bora 4 motion	99-05	HA	Achsschenkel oben	43,5	33902300	K 
Beetle	11-16	HA	Querlenker unten	41/42	33205301	S 
		HA	Querlenker oben	38/40	33236300	S
		HA	Hydro-, Kunststofflager	69	33224201	S hydr. 
Caddy	95-04	VA		60/31	33211300	S 
Caddy III	ab'03	VA	Konsole klein	62	33232302	K 
		VA	Querlenker	36,5	33532300	S 
		VA	Motorträger (Doppellager)	90	33239200/200	Z hydr. 
Corrado	87-95	VA		60/31	33211300	S 
		HA		44	33208300	S
		HA		56	33215302	S hydr.
Eos	ab'06	HA	Längslenker	60	33235300	S
		HA	Querlenker unten	41/42	33205301	S 
		VA	Querlenker	36,5	33532300	S 
		VA	Konsole klein	62	33232302	K 
		VA	Motorträger (Doppellager)	90	33239300/200	Z hydr. 
		HA	Achsschenkel hinten	36/38	33234300	K
		HA	Querlenker oben	38/40	33236300	S



KFZ und Reifen Wilkening, Quetzen, Herr Heiko Wilkening: „Also, ich kenne die Firma Paschke seit nun 23 Jahren. Wir haben schon viele Werkzeuge von denen für Radlager wie auch für Hinterachsbuchsen, die sehr gut sind. Ich muss aber besonderes Lob aussprechen beim kurzfristigen Entwickeln für neue Werkzeuge wie auch bei Sonderwünschen. Bei Fragen kann man mich gerne anhauen.“

Fabrikat-Typ	Baujahr	Achse		Ø mm	Artikel-Nr.	i.V.m.
Fox	05-11	HA	Hydro-, Kunststofflager	69	33224201	S hydr. 
		HA	Nur Kunststofflager	69	33223300	S
		VA		30	33233300	S
		VA	Konsole Aggregateträger	62	33232302	K 
Golf (auch Variant)	83-03	VA		60/31	33211300	S 
Golf II	84-92	HA		44	33208300	S
Golf III	92-97	HA		56	33215302	S hydr.
Golf Cabrio	98-02	HA		56	33215302	S hydr.
Golf III Variant	93-99	HA		56	33214300	S hydr.
Golf IV 4-motion	98-03	HA	Achsschenkel oben	43,5	33902300	K 
Golf IV	97-03	HA	Hydro-, Kunststofflager	69	33224201	S hydr. 
		HA	Nur Kunststofflager	69	33223300	S
Golf V + baugleich (z.B. Golf VI, VII, Scirocco)	ab`03	HA	Achsschenkel hinten	36/38	33234300	K
		HA	Längslenker	60	33235300	S
		HA	Querlenker oben	38/40	33236300	S
		HA	Kunststofflager	69	33237300	S/Z
		HA	Querlenker	41/42	33205301	S 
		VA	Querlenker	36,5	33532300	S 
		VA	Konsole klein	62	33232302	K 
		VA	Motorträger (Doppellager)	90	33239300/200	Z hydr. 
		VA		30	33233300	S
		VA	Konsole Aggregateträger	62	33232302	K 

GOLF V und baugleich

Vorderachse

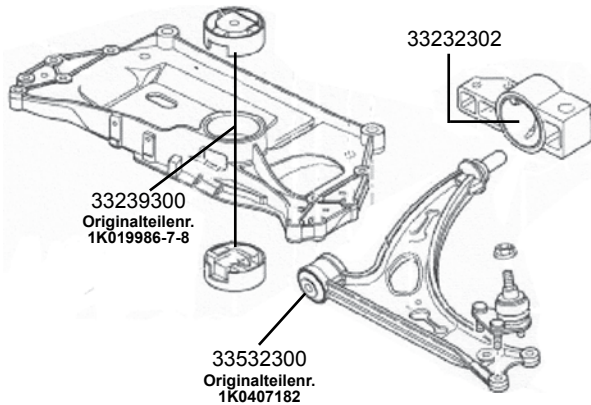

Hinterachse

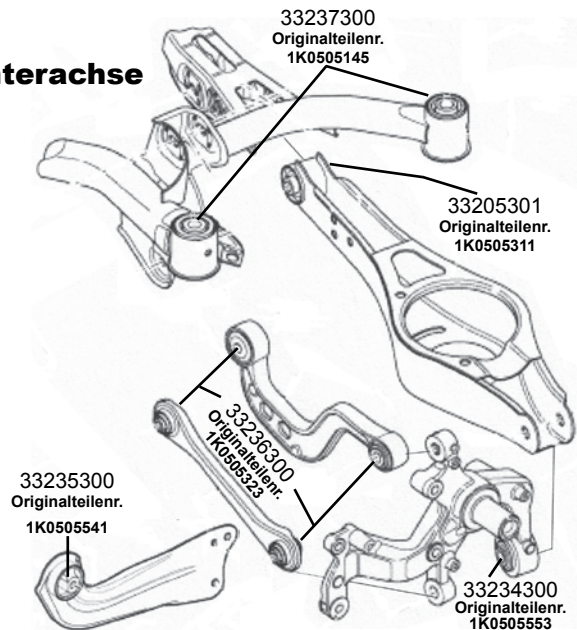

Fabrikat-Typ	Baujahr	Achse		Ø mm	Artikel-Nr.	i.V.m.
Jetta	84-92	HA		44	33208300	S
		VA	Querlenker	60/31	33211300	S 
Jetta	ab`05	HA	Querlenker unten	41/42	33205301	S 
		HA	Querlenker oben	38/40	33236300	S
		HA	Achsschenkel hinten	36/38	33234300	K
		HA	Längslenker	60	33235300	S
		VA	Konsole klein	62	33232302	K 
		VA	Querlenker	36,5	33532300	S 
		VA	Motorträger (Doppellager)	90	33239300/200	Z hydr. 
		HA	Achsschenkel hinten	36/38	33234300	K
Lupo	98-05	HA	Kunststofflager	56	33225300	S
New Beetle	97-05	VA	Querlenker	60/31	33211300	S 
		HA	Hydro-, Kunststofflager	69	33224201	S hydr. 
		HA	Nur Kunststofflager	69	33223300	S
		HA	Achsschenkel oben	43,5	33902300	K 



DRUCKSTÜCKSATZ VW Golf V, VA QL

Arbeitsbereich:

VA Querlenker Ø 36,5/37 i.V.m. Standard

Passend für:

Touran ab`03, Golf ab`03, Passat ab`05, Tiguan ab`07, Jetta ab`05, Caddy ab`04, Eos ab`06, Scirocco ab`08, Sharan ab`10, Passat ab`05, Audi A3 ab`03, TT ab`06, Skoda Superb ab`08, Skoda Octavia ab`04, Skoda Yeti ab`09, Seat Altea ab`04, Seat Toledo ab`04, Seat Leon ab`05, Seat Alhambra ab`10

DB Vito (W 638 / 639) ab`96, DB Viano (W 639) ab`03, DB V-Klasse (W 638/2) 96-03

Artikel-Nr.:

33532300

Fabrikat-Typ	Baujahr	Achse		Ø mm	Artikel-Nr.	i.V.m.		
Passat	80-88	VA, HA	Querlenker (Gummikragen)	37,5	33210 300	S		
		VA, HA	Querlenker (Metallkragen Ø 55)	37,5	33209 401	S 33206300 + 33209300		
		VA, HA	Querlenker Metallhülse	37,5	33209 300	S 33206300		
		HA		44	33204 300	S		
Passat	73-88	VA	Aggregateträger (alle 4 Lager)	37	33213 300	K		
Passat	88-97	HA		56	33214 300	S hydr.		
		VA	Querlenker	60/31	33211 300	S		
Passat	96-05	VA	Querlenker oben	46	33227 300	S		
		VA	Querlenker unten	65	33228 300	S		
		VA	Querlenker unten	40/50	33229 300	S		
		VA	Getriebeträger	71	33250 300	K		
Passat + baugleich (z.B. Tiguan)	ab`05	HA	Querlenker	41/42	33205 301	S		
		HA	Querlenker oben	38/40	33236 300	S		
		VA	Motorträger (Doppellager)	90	33239 300/200	Z hydr.		
		HA	Längslenker	60	33235 300	S		
		VA	Konsole klein	62	33232 302	K		
		VA	Querlenker	36,5	33532 300	S		
		HA	Achsschenkel hinten	36/38	33234 300	K		
Passat CC	ab`11	HA	Querlenker unten	41/42	33205 301	S		
Polo	75-94	VA		37/30	33203 300	S		
Polo	94-01	HA	Kunststofflager	56	33225 300	S		
		VA	Querlenker (auch Variant + Classic)	60/31	33211 300	S		
Polo 9N / 6R	ab`01	HA	Hydro-, Kunststofflager	69	33224 201	S hydr.		
		HA	Nur Kunststofflager	69	33223 300	S		
Sharan	95-10	VA, HA	Querlenker unten	35/45	33220 301	S		
		HA		95	33246 300	Z hydr.		
	ab`10	VA	Querlenker	36,5	33532 300	S		
		HA	Achsschenkel hinten	36/38	33234 300	K		
		HA	Querlenker oben	38/40	33236 300	S		
		VA	Motorträger (Doppellager)	90	33239 300/200	Z hydr.		
Touareg	ab`03	VA	Querlenker alle 3 Lager	40/46/60	33249 300 /401	S		
Touran	ab`03	HA	Querlenker	41/42	33205 301	S		
		HA	Achsschenkel hinten	36/38	33234 300	K		
		HA	Längslenker	60	33235 300	S		
		HA	Querlenker oben	38/40	33236 300	S		
		HA	Achskörper	69	33237 301	Z		
		VA	Konsole klein	62	33232 302	K		
		VA	Querlenker	36,5	33532 300	S		
		VA	Motorträger (Doppellager)	90	33239 300/200	Z hydr.		
		Up	ab`11	VA	Querlenker	60/31	33211 300	S
				HA		56	33248 300	S
Vento	92-98	VA		60/31	33211 300	S		
		HA		56	33215 302	S hydr.		
T4	90-03	HA	Achsschenkel	44	33222 300	S		
		VA	Querlenker unten	35/45	33220 301	S		
		VA	Querlenker unten	40/45	33220 310	S		
		VA	Traggelenk oben	46	33221 302	S		
		VA	Traggelenk oben m.Sturzeinstellplatte	45/46	33231 300	D hydr.		
		VA	Traggelenk oben m.Sturzeinstellplatte	45/46	33519 302	D hydr.		

DRUCKSTÜCKSATZ VW T5, HA QL

Arbeitsbereich:

HA Querlenker Ø 60 i.V.m. Standard

Passend für:

T5, T6

Artikel-Nr.:

33247300

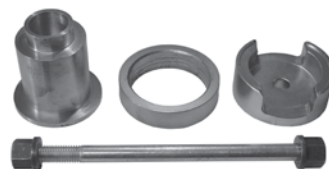

Fabrikat-Typ	Baujahr	Achse		Ø mm	Artikel-Nr.	i.V.m.	
T5	ab`03	VA	Querlenker unten	40	33240300	S	
		VA	Querlenker unten	60	33241300	S	
		VA	Traggelenkkonus aus QL drücken		33517301	D hydr.	
		HA	Querlenker hinten beide Lager	60	33247300	S	

DRUCKSTÜCKSATZ VW Crafter, VA Traggelenk

Arbeitsbereich:

VA Traggelenk Ø 45 i.V.m. Standard

Passend für:

LT ab`96, Crafter ab`06, Sprinter ab`96.

Artikel-Nr.:

33513303



Fabrikat-Typ	Baujahr	Achse		Ø mm	Artikel-Nr.	i.V.m.	
LT	96-06	VA, HA	Stoßdämpfergummi	30-40	33507300	S	
LT		VA, HA	Stabi	26	33504301	K	
		VA	Traggelenk (Kragen Ø 60/62)	45	33513303	S hydr.	
		VA	Traggelenkkonus aus Achsschenkel drücken		33517301	D hydr.	
		VA	Querlenker 2 Lager	38	33523300	S	
Crafter	ab`06	VA	Traggelenk (Kragen Ø 60)	45	33525300	S hydr.	
		VA	Traggelenkkonus aus Achsschenkel drücken		33517301	D hydr.	
		VA	Querlenker 2 Lager	47	33526300	S	

DRUCKSTÜCKSATZ Volvo V40 II, V50, VA QL

Arbeitsbereich:

VA Querlenker Ø 74/90 i.V.m. Standard

Passend für:

V40 II/ V50 ab`04, C30 ab`06, S60, V60, XC60 ab`10, C70 ab`06, C70 ab`06,

C70 ab`10, S80 ab`06, Mazda 3 03-09, Mazda 5 ab`03,

FORD: Mondeo ab`07, S-Max ab`06, Galaxy ab`06, Focus II ab`04,

C-Max ab`07, Kuga ab`08

Artikel-Nr.:

33418300

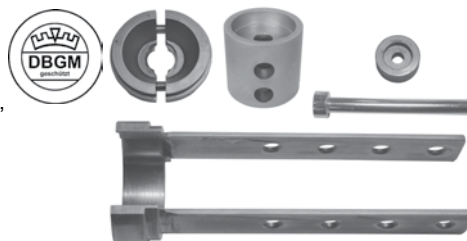

Fabrikat-Typ	Baujahr	Achse		Ø mm	Artikel-Nr.	i.V.m.	
C30	06-12	HA	Längslenker	60	33408300	S	
		VA	Querlenker Lagerbock	74	33418303	S	
C70	ab`06	VA	Querlenker Lagerbock	74	33418303	S	
V40, S40	95-04	HA	Längslenker (Schlitz- und Stahlbuchse)	70	33710300	S	
V40, S40	95-04	HA	Längslenker (nur Stahlbuchse)	70	33710401	S	
		VA	Querlenker Lagerbock	74	33418303	S	
S40 II, V40	ab`04	HA	Längslenker	60	33408300	S	
		VA	Querlenker Lagerbock	74	33418303	S	
V50	04-12	HA	Längslenker	60	33408300	S	
S60, V60, XC60	ab`10	HA	Längslenker	90	33416200/300	K	
		VA	Querlenker Lagerbock	90	33418303	S	
S60, V60		VA	Querlenker	60	33417300	S	
XC60	ab`10	HA	Längslenker	90	33416200/300	K	
V70, XC70	ab`10	HA	Längslenker	90	33416200/300	K	
		VA	Querlenker	60	33417300	S	
V70		VA	Querlenker Lagerbock	90	33418303	S	
		VA	Querlenker	60	33417300	S	
V80		VA	Querlenker	60	33417300	S	
S80	ab`06	HA	Längslenker	90	33416200/300	K	
		VA	Querlenker Lagerbock	90	33418303	S	